

9" EXTENSION FOR 2 1/2" CURB BOX

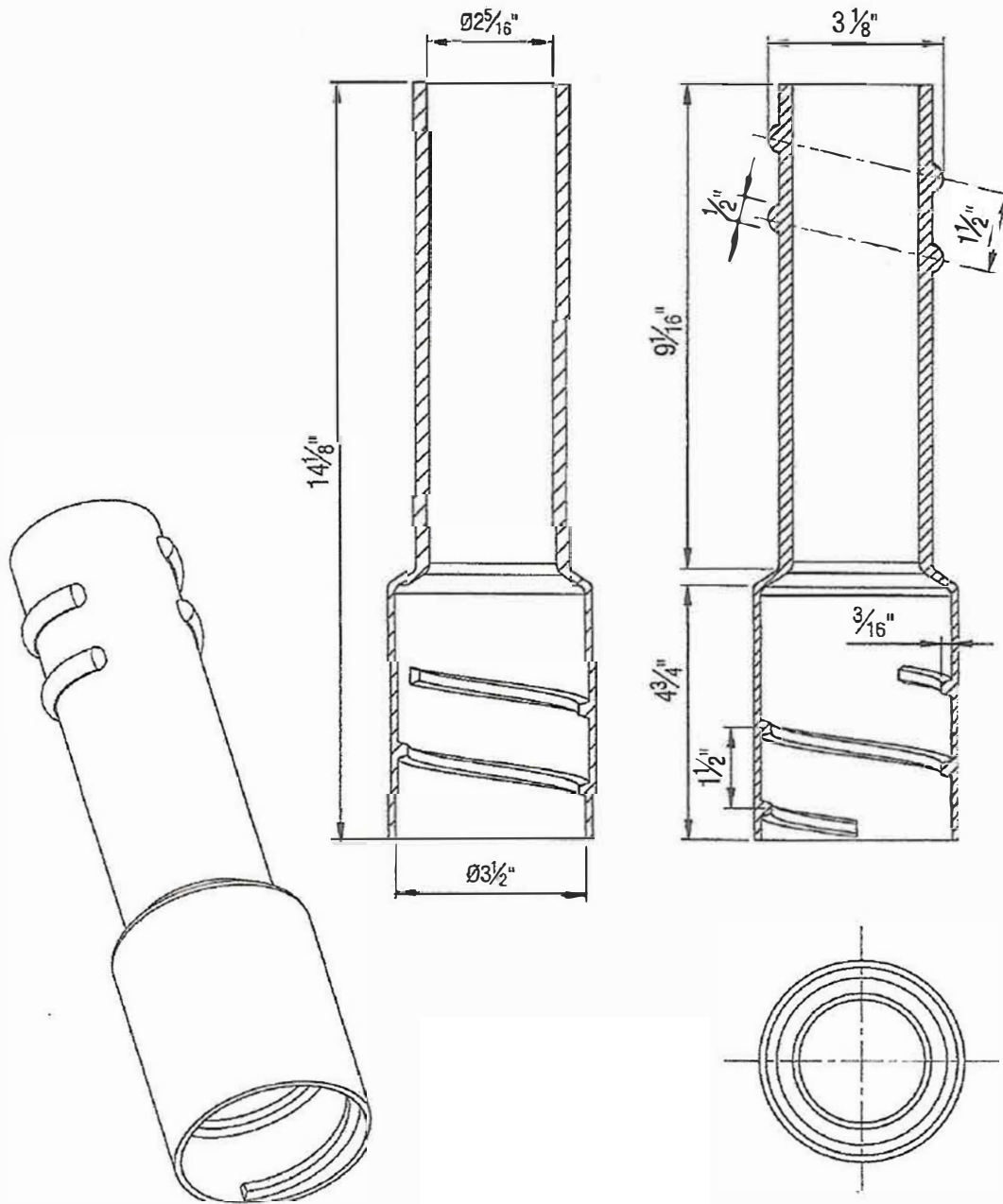

MATERIAL :- ASTM A48 CLASS 30B

151EXT



CAST IRON & PLASTIC MANUFACTURING & SALES

3700 CLARKSTOWN ROAD, MUNCY, PA 17756 PHONE 570-546-2109 WEBSITE: CANDPMANUFACTURING.COM