

Complete Box Side View

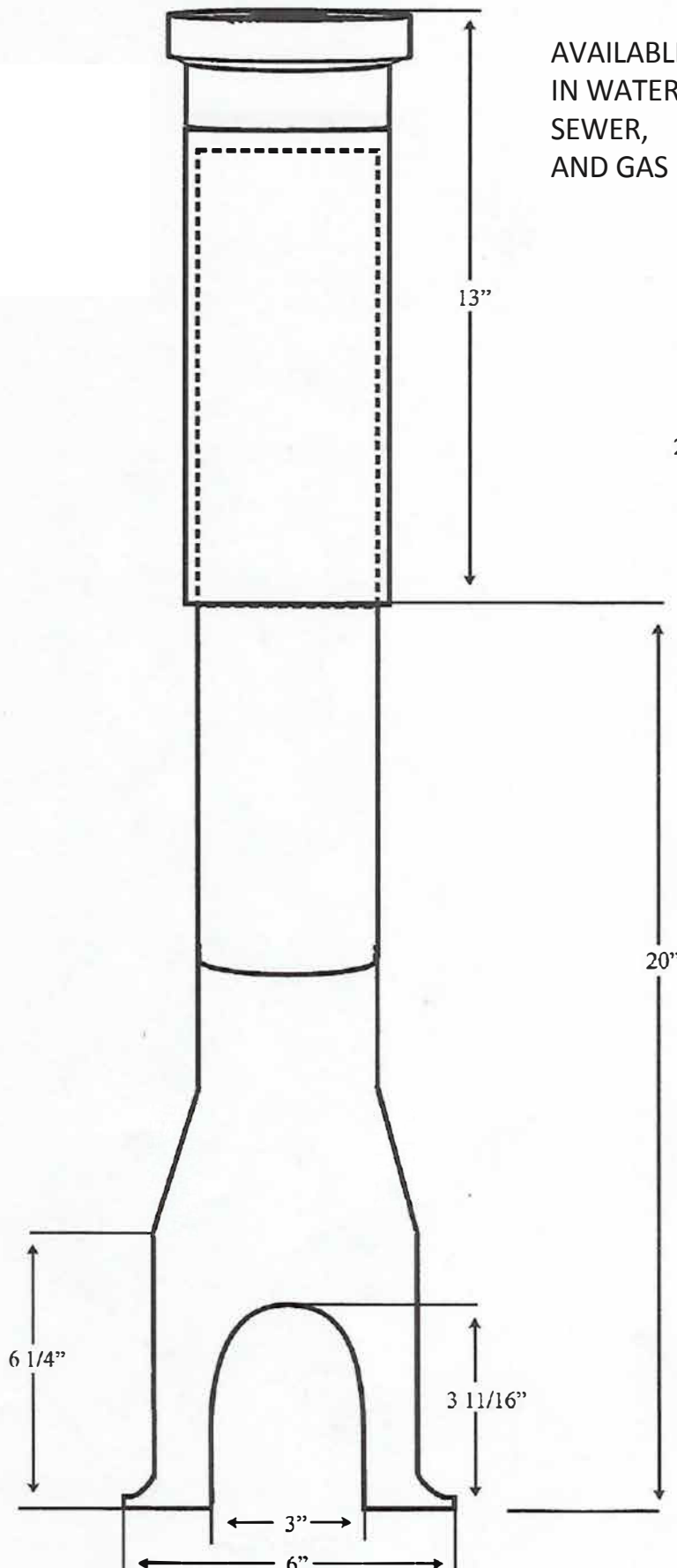

AVAILABLE
IN WATER,
SEWER,
AND GAS

Lid Top View

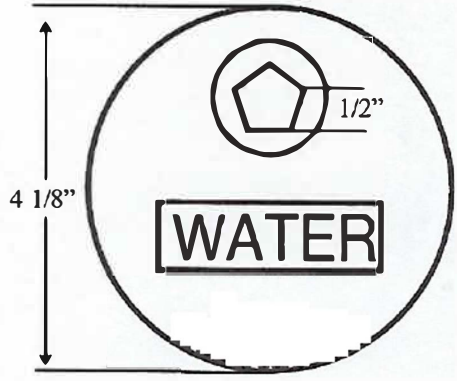

Collar Side View

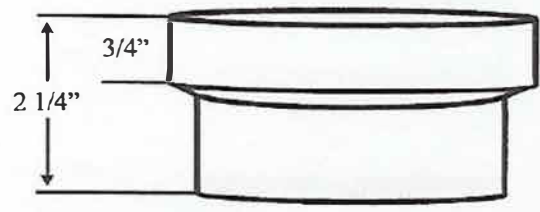

Collar Top View

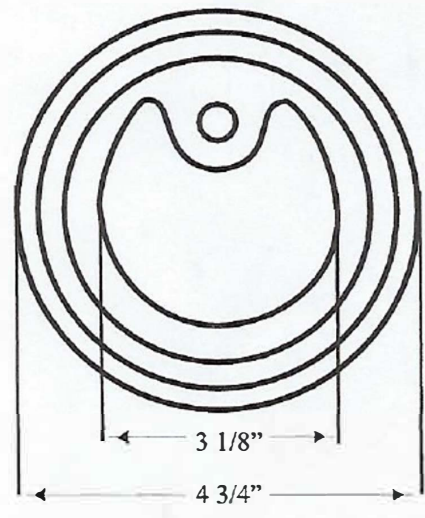

Figure # 3111212PBSA
3" Curb Box Complete Extension
Range 18" - 30"
Combination Cast Iron/ABS Slip
Type
Standard Arch

Casting conforms to:
ASTM specifications A-48 Class 25

ABS conforms to:
ASTM-D 1788

