

Complete Box Side View

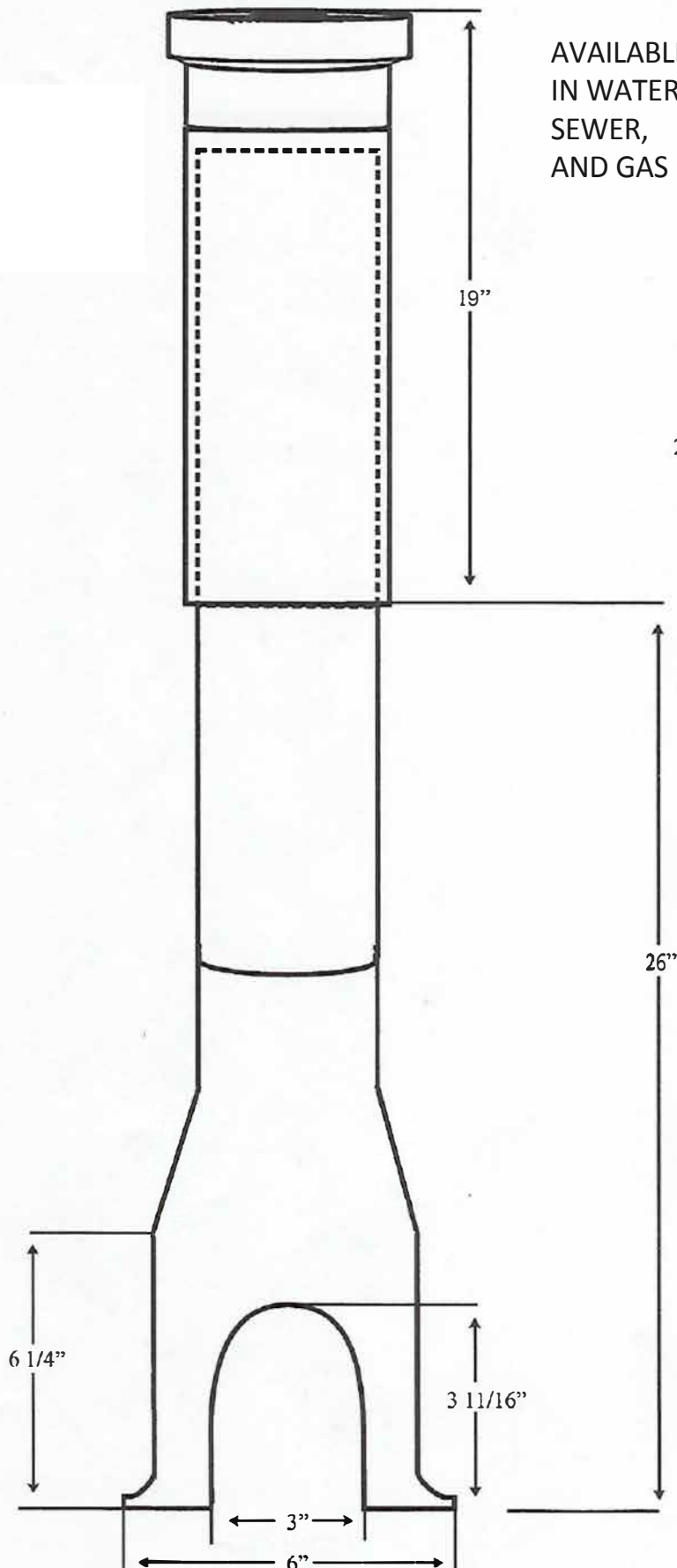

AVAILABLE
IN WATER,
SEWER,
AND GAS

Lid Top View

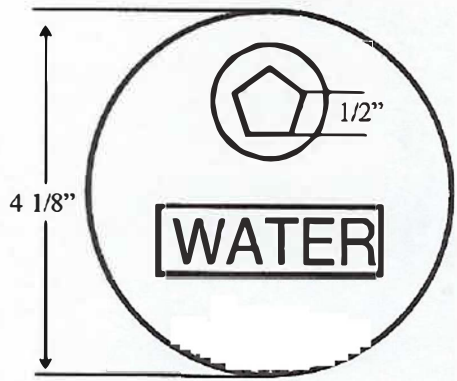

Collar Side View

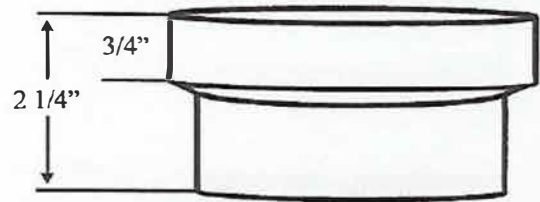

Collar Top View

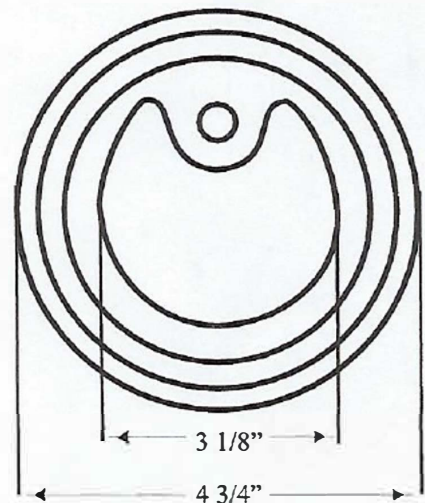

Figure # 311818PBSA
3" Curb Box Complete Extension
Range 30" - 42"
Combination Cast Iron/ABS Slip
Type
Standard Arch

Casting conforms to:
 ASTM specifications A-48 Class 25

ABS conforms to:
 ASTM-D 1788

