

Complete Box Side View

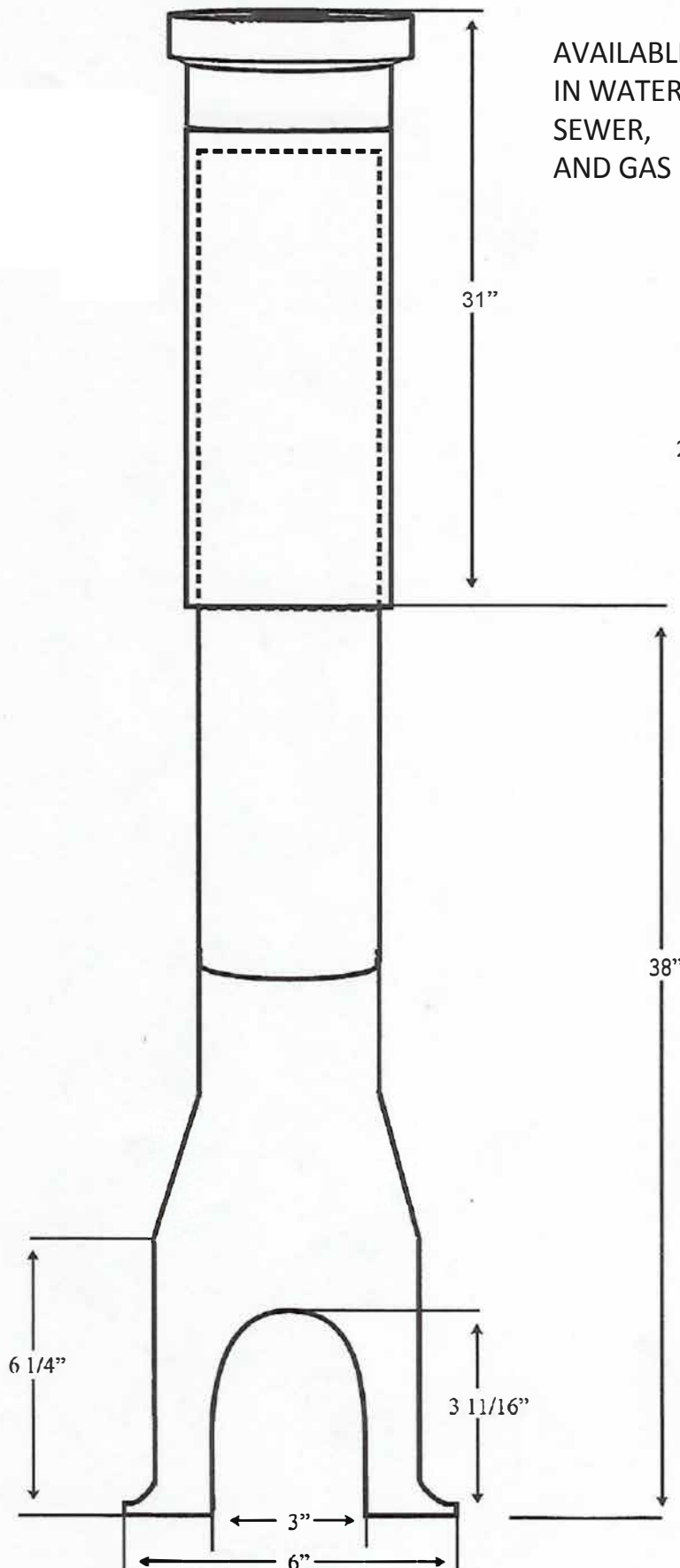

AVAILABLE  
IN WATER,  
SEWER,  
AND GAS

Lid Top View

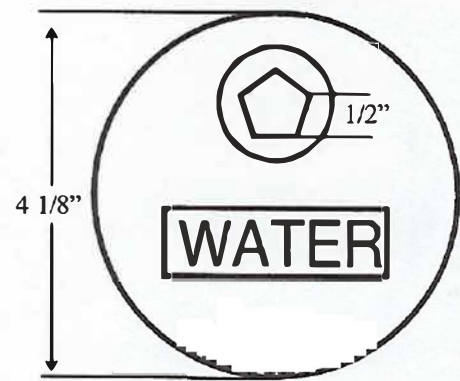

Collar Side View

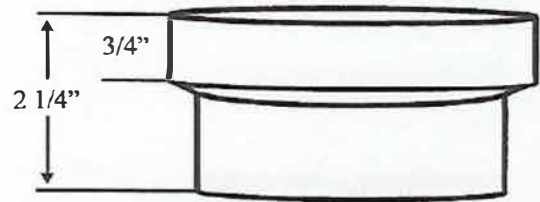

Collar Top View

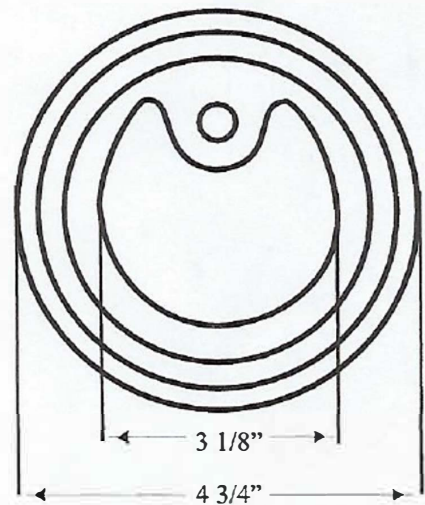

**Figure # 3113030PBSA**  
**3" Curb Box Complete Extension**  
**Range 42" - 66"**  
**Combination Cast Iron/ABS Slip**  
**Type**

**Standard Arch**

Casting conforms to:  
 ASTM specifications A-48 Class 25

ABS conforms to:  
 ASTM-D 1788

